

1

2

3

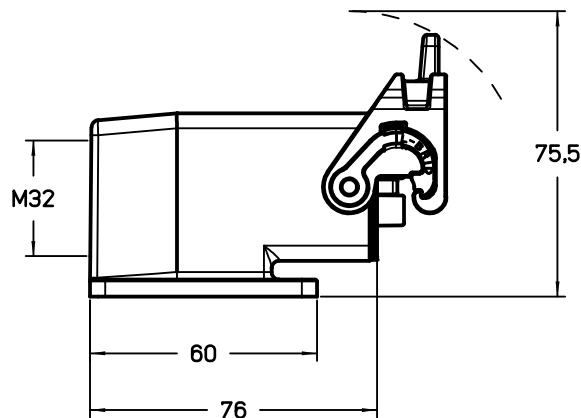
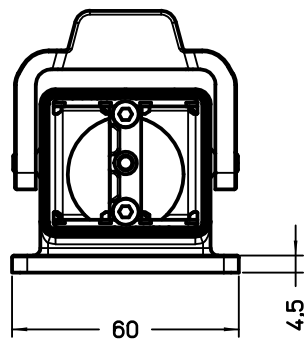
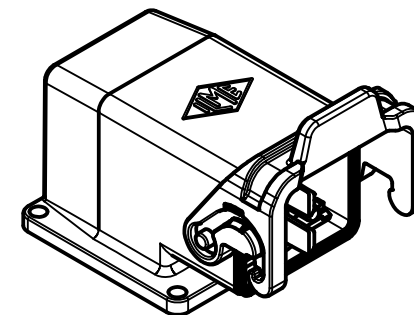
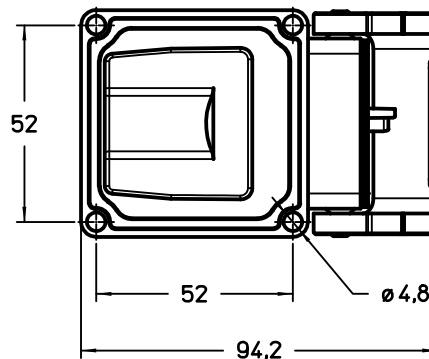
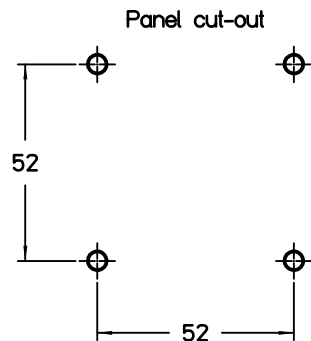

REV.	DATE	SIGNATURE		
Dimensions in mm		Simplified representation with dimensions without tolerance		
Original Size A4		MXA 02 AP32		Scale 1:2
Date 27/11/23		Angled metal surface mounting housing, 1 lever and gasket		
Sign. S.Diasparra		with closed bottom flange, M32 entry		

1

2

3

